



LC1486C

600mA High PSRR, Fast Response Linear Regulator

DESCRIPTION

LC1486C series is a group of positive voltage output, low power consumption, low dropout voltage regulator.

LC1486C can provide output value adjustable from 0.8V to 5.0V.

LC1486C includes high accuracy voltage reference, error amplifier, current limit circuit and output driver module with discharge capability.

LC1486C has excellent load and line transient response and good temperature characteristics, which can assure the stability of chip and power system. It uses trimming technique to guarantee output voltage accuracy within $\pm 2\%$. And it also provides fold back short-circuit protection, thermal shutdown and output current limit function.

LC1486C is available in SOT23-5 package which is lead free.

FEATURES

- Low power consumption: 65uA (Typ.)
- Maximum output current: 600mA
- Low dropout voltage:
360mV@ $I_{OUT}=600mA$, $V_{OUT}=3.3V$
- Build-in chip enable and discharge circuit
- Input voltage range: 2~6V
- Adjustable output from 0.8V to 5.0V
- Output voltage accuracy: $\pm 2\%$
- Output current limit
- Short circuit protection
- Over temperature protection

APPLICATIONS

- Power source for cellular phones and various kind of PCSs
- Battery powered equipment
- Power management of MP3, PDA, DSC, Mouse, PS2 games
- Reference voltage source
- Regulation after switching power

TYPICAL APPLICATION

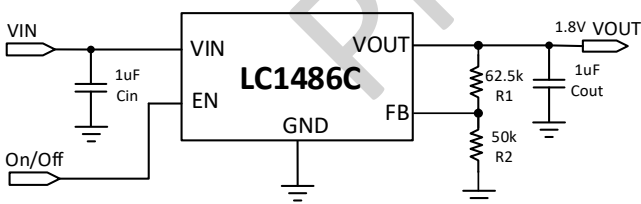

Note:

$$1) V_{OUT} = V_{FB} * (1 + \frac{R1}{R2}), V_{FB} = 0.8V$$

PIN OUT & MARKING

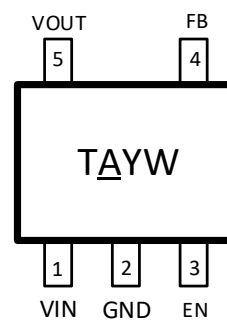

SOT23-5

TA: Product code

YW: Date code (Year & Week)

ORDERING INFORMATION

Part No.	Package	Tape&Reel
LC1486CCB5TR	SOT23-5	3000pcs/reel

ABSOLUTE MAXIMUM RATING

Parameter	Value
Max input voltage	8V
Operating junction temperature(T _J)	125°C
Power dissipation	400mW
Package thermal resistance (θ _{JA})	SOT23-5 220°C/W
Storage temperature(T _s)	-40°C -150°C
Lead temperature & time	260°C,10S

Note: Exceed these limits to damage to the device. Exposure to absolute maximum rating conditions may affect device reliability.

RECOMMENDED WORK CONDITIONS

Parameter	Value
Input voltage range	2V to 6V
Ambient temperature	-40°C –85°C

ELECTRICAL CHARACTERISTICS

(Test Conditions: C_{IN}=1uF, C_{OUT}=1uF, T_A=25 °C, unless otherwise stated.)

Symbol	Parameter	Conditions	Min	Typ	Max	Units
V _{IN}	Input voltage		2 ¹		6	V
V _{FB}	Regulated feedback voltage	V _{IN} =3.3V, I _{OUT} =10mA	0.784	0.8	0.816	V
V _{DROP}	Dropout voltage ²	V _{OUT} =1.2V, I _{OUT} =600mA		1020	1200	mV
		V _{OUT} =1.8V, I _{OUT} =600mA		630	750	mV
		V _{OUT} =3.3V, I _{OUT} =600mA		360	450	mV
$\frac{\Delta V_{out}}{\Delta V_{in} \cdot V_{out}}$	Line regulation	I _{OUT} =10mA, 2.5V≤V _{IN} ≤6V		0.05	0.2	%/V
ΔV _{out}	Load regulation	V _{IN} =4.3V, V _{OUT} =3.3V 10mA≤I _{OUT} ≤600mA		50	80	mV
I _Q	Supply current	V _{IN} = V _{OUT} +1V, V _{IN} = V _{EN}		65	100	uA
I _{STANDBY}	Supply current (standby)	V _{IN} = V _{OUT} +1V, V _{EN} =GND		0.1	1.0	uA
$\frac{\Delta V_{out}}{\Delta T \cdot V_{out}}$	Output voltage temperature coefficient	I _{OUT} =10mA		±100		ppm/°C
PSRR	Ripple rejection	F=1KHz, Ripple=1Vp-p V _{IN} = V _{OUT} +1V		65		dB
I _{LIM}	Current limit	V _{IN} =4.3V, V _{OUT} =3.3V	600			mA
I _{SHORT}	Short current limit	V _{IN} =5V, V _{OUT} =0V		100		mA
R _{DISCHARGE}	Discharge resistor	EN=0, V _{OUT} =3V		2K		Ω
V _{ENH}	EN input voltage “H”		1.5		V _{IN}	V
V _{ENL}	EN input Voltage “L”		0		0.4	V
T _{SD}	Thermal shutdown temp			150		°C
T _{SH}	Thermal shutdown hysteresis			25		°C

Note: 1) The output current capability depends on the input voltage and the minimum dropout voltage.

2) V_{DROP}= V_{IN}- V_{OUT} when V_{OUT} drops below 98% of the normal V_{OUT}.

PIN DESCRIPTION

Pin #	Name	Description
1	VIN	Supply voltage input. Supply voltage can range from 2V to 6V.
2	GND	Ground pin
3	EN	Enable pin. This pin has an internal pull-down resistor. A logic low reduces the supply current to less than 1 μ A. Connect to IN for normal operation.
4	FB	Feedback pin. This is used to set the output voltage of the device.
5	VOUT	Output voltage

BLOCK DIAGRAM

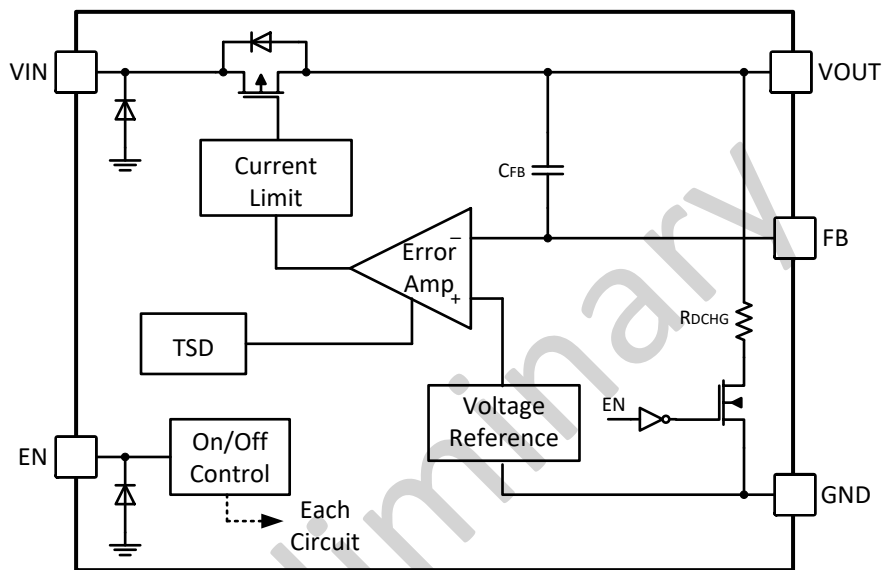

EXPLANATION

LC1486C series is a group of positive voltage output, low noise, low power consumption, low dropout voltage regulator.

LC1486C can provide output value adjustable from 0.8V to 5.0V.

LC1486C includes high accuracy voltage reference, error amplifier, current limit circuit and output driver module.

LC1486C has excellent load and line transient response and good temperature characteristics, which can assure the stability of chip and power system. It uses trimming technique to guarantee output voltage accuracy within $\pm 2\%$. And it also provides fold-back short-circuit protection, thermal protection and output current limit function.

TYPICAL PERFORMANCE CHARACTERISTICS

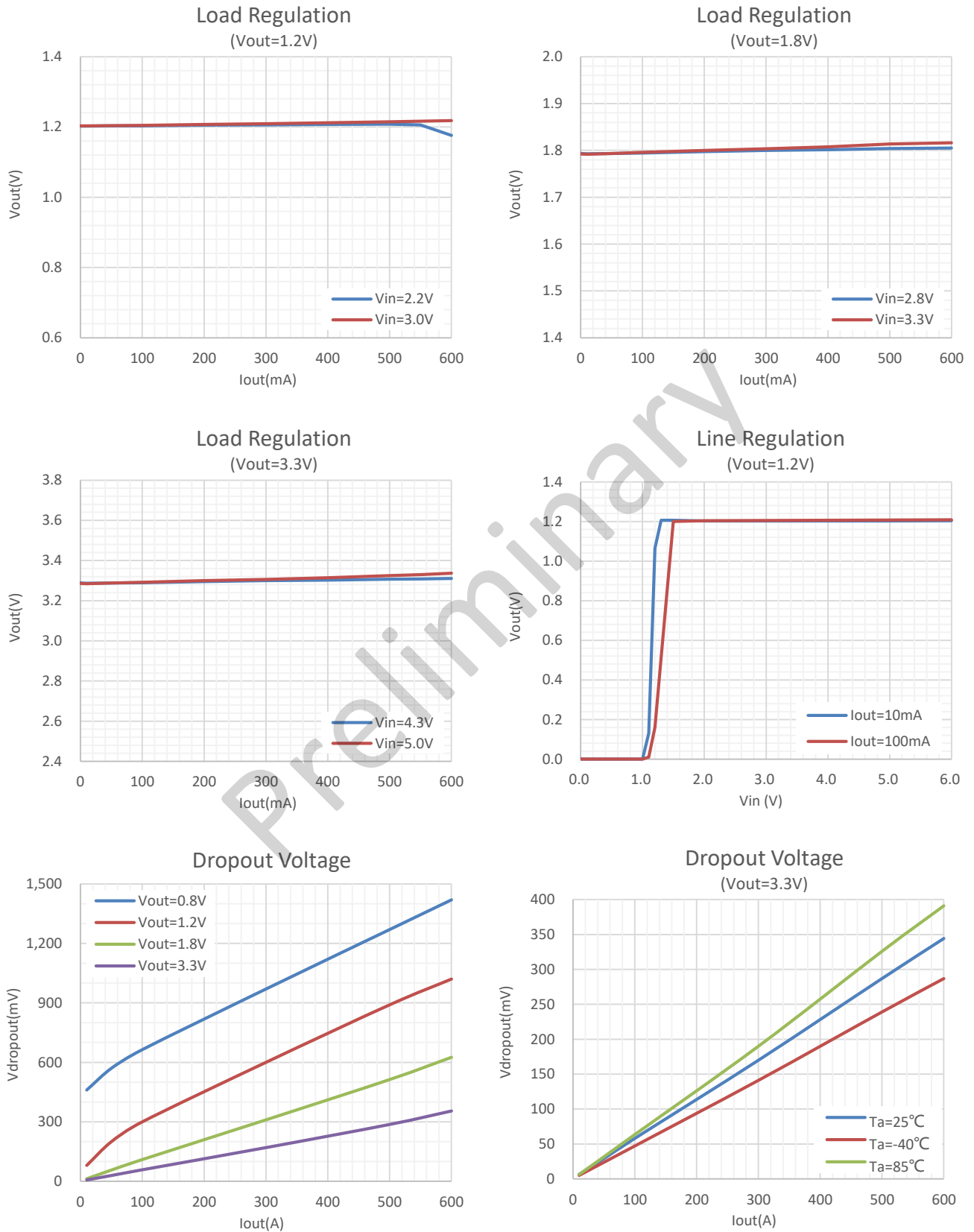

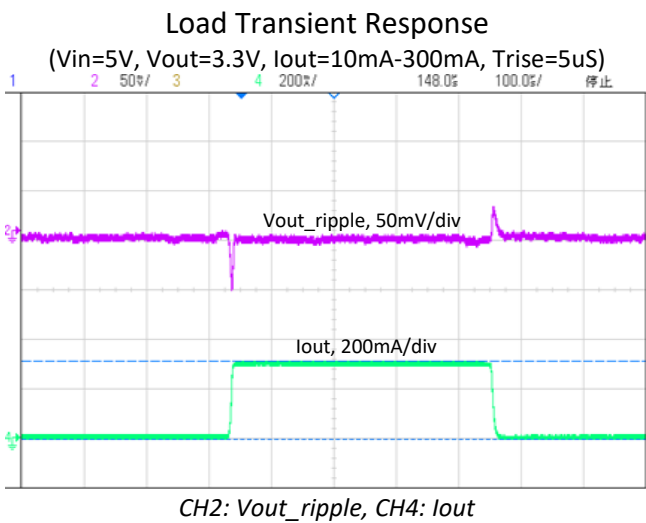
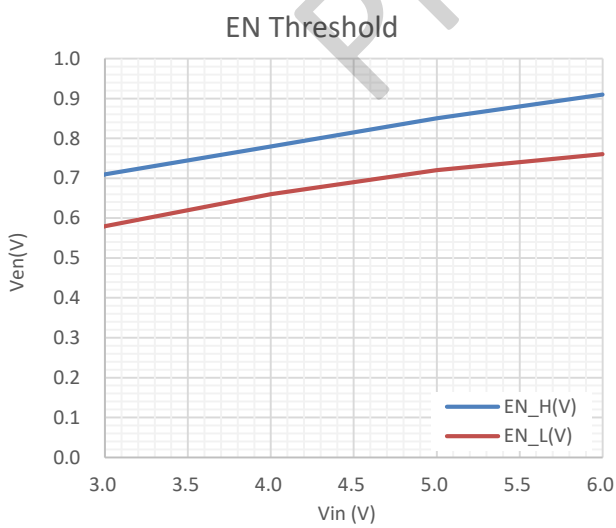
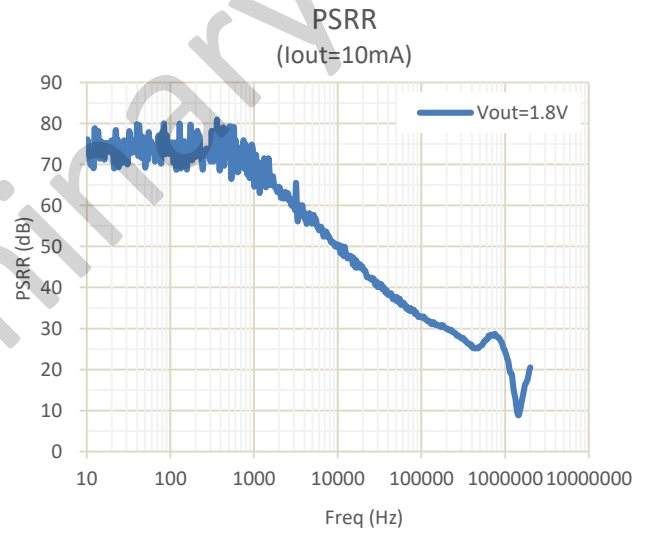
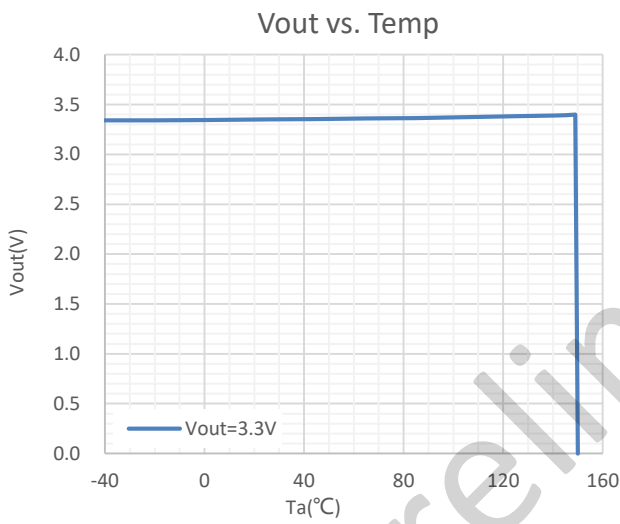
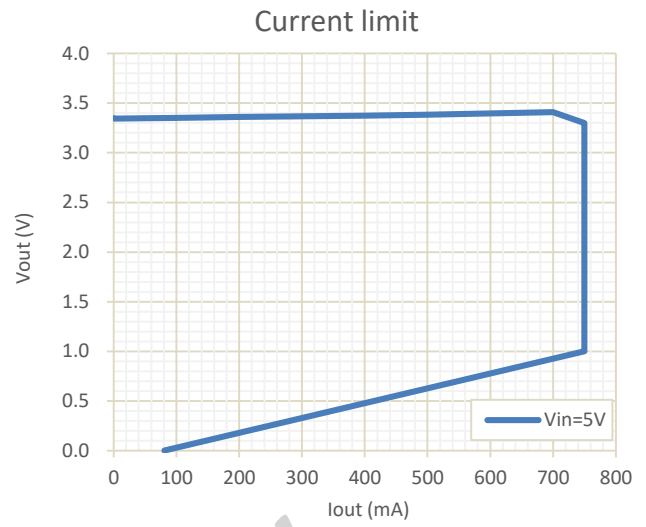
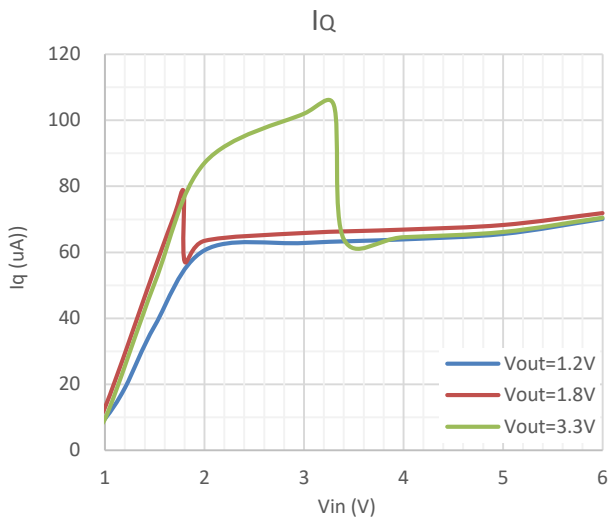

EN Chip Enable Response

(EN=0V to 3V, Vin=5V, Vout=1.2V, Iout=10mA)

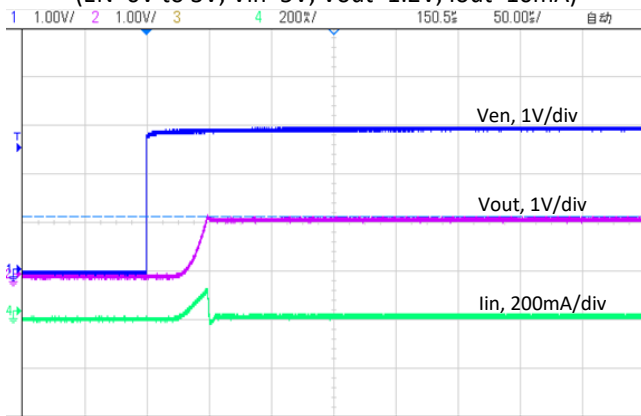

EN Chip Enable Response

(EN=3V to 0V, Vin=5V, Vout=1.2V, Iout=10mA)

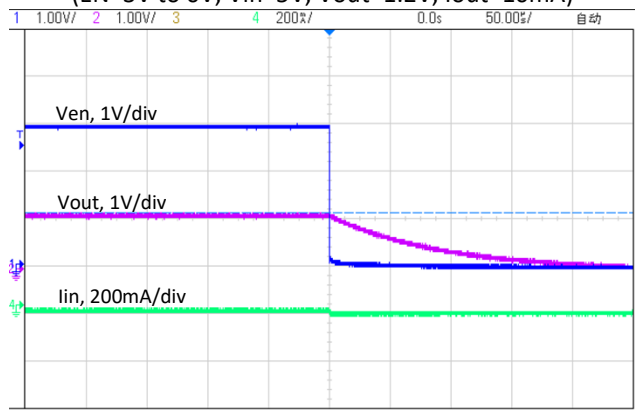

Preliminary

PACKAGE OUTLINE

Package	SOT-23-5	Devices per reel	3000pcs			
Package dimension:						
SECTION B-B						
	COMMON DIMENSION (MM)			DIMENSION In Inches		
PKG	SOT23-5L			SOT23-5L		
REF.	MIN.	NOM.	MAX	MIN.	NOM.	MAX
A	-	-	1.250	-	-	0.049
A1	0.000	-	0.150	0.00	-	0.006
A2	1.000	1.100	1.200	0.039	0.043	0.047
A3	0.600	0.650	0.700	0.024	0.026	0.028
b	0.360	-	0.500	0.014	-	0.020
b1	0.360	0.380	0.450	0.014	0.015	0.018
c	0.140	-	0.200	0.006	-	0.008
c1	0.140	0.150	0.160	0.006	0.006	0.006
D	2.826	2.926	3.026	0.111	0.115	0.119
E	2.600	2.800	3.000	0.102	0.110	0.118
E1	1.526	1.626	1.726	0.060	0.064	0.068
e	0.900	0.950	1.000	0.035	0.037	0.039
e1	1.800	1.900	2.000	0.071	0.074	0.079
L	0.350	0.450	0.600	0.014	0.018	0.024
L1	0.590REF			0.023REF		
L2	0.250BSC			0.010BSC		
R	0.050	-	-	0.002	-	-
R1	0.050	-	0.200	0.002	-	0.008
theta	0°	-	8°	0°	-	8°
theta1	3°	5°	7°	3°	5°	7°
theta2	6°	-	14°	6°	-	14°

Unit: mm